

# Paper Format for Symposium on VLSI Technology and Circuits in Two-Column Format

Center the Authors Names Here

Center the Affiliations, City, States and Country

## Abstract

The abstract is a concise (60 to 150 words) summary of your 3 page paper, providing an overview of the research. This is an important aspect of your paper, as it is this description that may attract the reader. Key performance and figures of merit are often mentioned in the abstract.

**Keywords (optional):** Each keyword, except proper nouns and acronyms, should be typed in lower-case letters and followed by a comma, except for the last one.

## Introduction

These guidelines help prepare camera-ready papers for the VLSI Symposium. Note that papers that do not follow the guideline will be rated unfavorably. The aim is to closely simulate the appearance of published papers in the VLSI Symposium Digests. Your manuscript should be IEEE Xplore-compatible through PDF eXpress during submission.

Space is a precious resource in VLSI Symposium papers. Typically, there are no empty lines between section titles and text. If the text starts on the same line as the Section title, emphasize the title in bold or italic. Subsections are rarely used but can be highlighted with italicized fonts and continued on the same line.

Several past VLSI papers had issues with text in the figures too small to read when printed on paper. To address this, the paper length has been increased from 2 to 3 pages, doubling the area available for figures so that larger font sizes can be used. The amount of information should not exceed past VLSI papers. For instance, doubling the number of figures with the same font size as in past VLSI papers is prohibited. The font size of the text in the figures must be at least 8 points. Papers that violate the font size rule will be rated unfavorably.

The second and third pages are divided into a 2 x 3 grid, creating six panes which are primarily for figures, but can also be used for references if needed. The main text, acknowledgments, and references should be on page 1, with the figures on the subsequent pages. If space on page 1 is insufficient, the six panes of page 3 can be used for references.

(1) *Paper size:* Prepare camera - ready paper in full size format, on A4 size or 8 1/2" x 11" (215.9 mm x 279.4 mm) paper.

(2) *Fonts:* The best results are obtained by careful and effective use of several font sizes. Do not use fonts smaller than the fonts specified in Table I. As an aid to gauging font size, 1 point is about 0.35 mm. Use a proportional, serif font such as Times or Dutch Roman. Arial and Calibri fonts are often used for figure captions and labels.

(3) *Formats:* In formatting your A4-size paper, set top margin to 20 mm (0.79 inches), bottom margin to 25 mm (0.98 inches), left margin to 14 mm (0.55 inches) and right margin to 15 mm (0.59 inches). If you are using paper 8 1/2" x 11", set the top margin to 10 mm (0.39 inches), bottom margin to 17.4 mm (0.69 inches), left margin to 17 mm (0.67 inches), and right margin to 17.9 mm (0.70 inches). The column width is 88 mm (3.46 inches) with 5 mm (0.20 inches) space between the two columns.

You should left- and right-justify your columns. On the last page of your paper, try to adjust the lengths of the two columns so that they are the same. Use automatic hyphenation, if you have it. Don't forget to check spelling.

## Illustrations

The font size of the text in the figures must be at least 8 points. Papers that violate the font size rule will be rated

unfavorably. Figure captions should be below the figures; table captions should be above the tables. Use the abbreviation (e.g., "Fig.1") for immediate identification even at the beginning of a sentence. Curves in the graphs can be colored, but should also be legible when printed in B/W. To this end, use appropriate symbols and line styles (solid, dashed, etc.). Make sure all figures captions, legends, tick and axis labels are easily readable.

## Helpful Hints

*A. References:* Place a list of numbered references at the end of the paper. When references are made in the main text, the corresponding reference number should be included in square brackets [1]. The sentence punctuation follows the brackets. Cited references should unambiguously identify the source. Use complete citations if space allows, i.e., state the paper title and the names of all authors. Unpublished papers should be cited as "unpublished" [4], and accepted papers as "in press" [5]. Capitalize only the first word in the paper title, except for proper nouns and element symbols. For papers in translated journals, give the English citation first, followed by the original foreign-language citations [6]. Add a hyperlink to each paper for easy retrieval (this requirement is removed as of 17-Jan-2025)

*B. Abbreviations and Acronyms:* Define abbreviations and acronyms the first time they are used. Acronyms such as MOSFET, ac and dc etc. do not have to be defined. Redefine acronyms when first used in the text, even if they have been defined in the abstract.

*C. Equations:* Number equations consecutively with equation numbers in parentheses flush with the right margin, as in (1). To make your equations more compact, you may use the solidus (/), the exp function, or appropriate exponents. Italicize Roman symbols for quantities and variables, but not Greek symbols. Use a long dash rather than a hyphen for a minus sign. Use parentheses to avoid ambiguities in denominators. Punctuate equations with commas or periods when they are part of a sentence, like this,

$$f(x) = a_0 + \sum_{n=1}^{\infty} \left( a_n \cos \frac{n\pi x}{L} + b_n \sin \frac{n\pi x}{L} \right). \quad (1)$$

Be sure that all the symbols in your equation have been defined before the equation appears or immediately afterwards. When you refer to equations in the text, refer to (1). Do not use "Eq. (1)" or "Equation (1)" except at the beginning of a sentence: "Equation (1) is used..."

**Acknowledgements** to people, funding agencies, projects can appear at the end of the text or immediately before the references.

## References

- [1] Z. Zhou *et al.*, *IEEE TED*, vol. 71, no. 8, pp. 4445–4452, 2024.
- [2] P. Jiang *et al.*, *IEDM*, 2023, pp. 1–4.
- [3] Q. Xie *et al.*, *Symp. on VLSI*, 2023, pp. 1–2.
- [4] A.Einstein, Ph. D. dissertation, XYZ-Univ., Unpublished.
- [5] T.A. Edison, in press, ABC\_Journal.
- [6] T. Kodera, *JSAP Rev.* 2024 240101 / *Oubutsu* 2023 p713-722.
- [7] G. Park *et al.*, *ISSCC*, 2024, pp. 374–376.
- [8] N. Zeng *et al.*, *Symp. on VLSI*, 2023, pp. 1–2.
- [9] T. Lu and S. Du, *CICC*, 2024, pp. 1–2.
- [10] S. Balamurali *et al.*, *ESSCIRC*, 2023, pp. 125–128.
- [11] Y. Iizuka *et al.*, *A-SSCC*, 2023, pp. 1–3.

TABLE I. Font sizes for camera-ready papers

Font Size	Bold	Italic	Text
10			Main text, authors' affiliations
10	Yes		Headings, i.e. <b>Abstract</b>
12			Authors' names
14	Yes		<b>Paper title</b>
10		Yes	Sub-headings, i.e., <i>Fonts</i>
9			References, table, table names, table captions, figure captions
8			Footnotes, sub- and superscripts

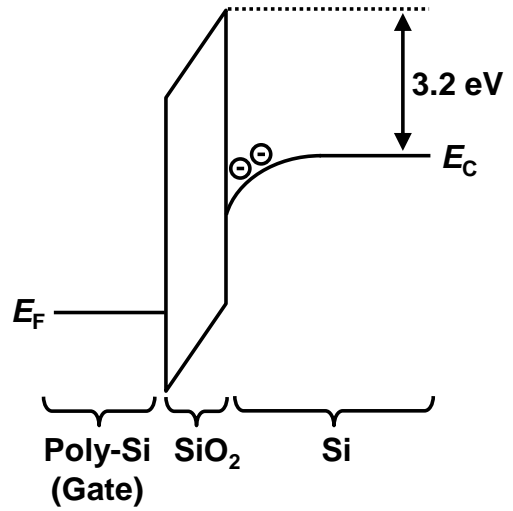

Fig. 1. Write the figure caption here. The font size of the text in the figures must be at least 8 points. Papers that violate the font size rule will be rated unfavorably.

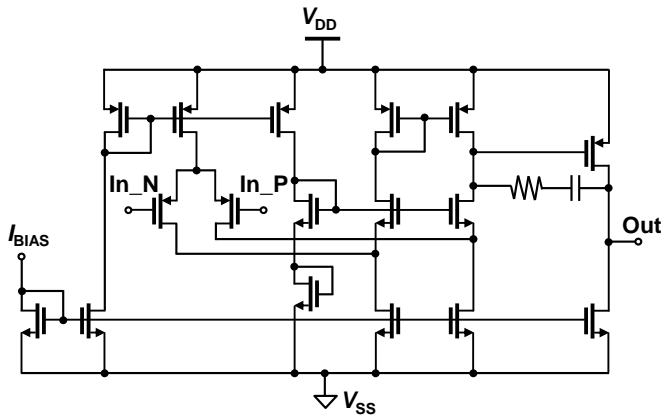

Fig. 2. Write the figure caption here. The font size of the text in the figures must be at least 8 points. Papers that violate the font size rule will be rated unfavorably..

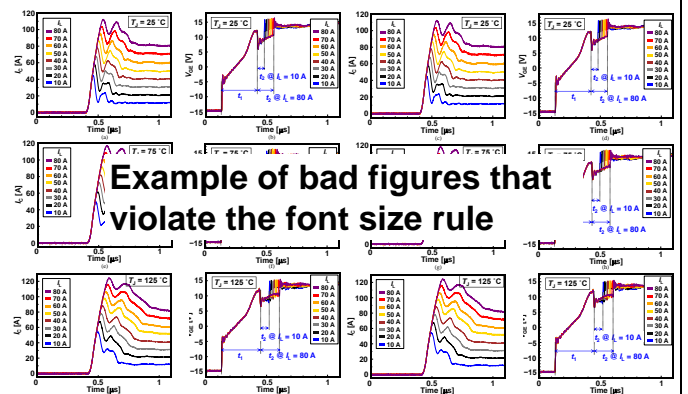

Fig. 3. Write the figure caption here. The font size of the text in the figures must be at least 8 points. Papers that violate the font size rule will be rated unfavorably..

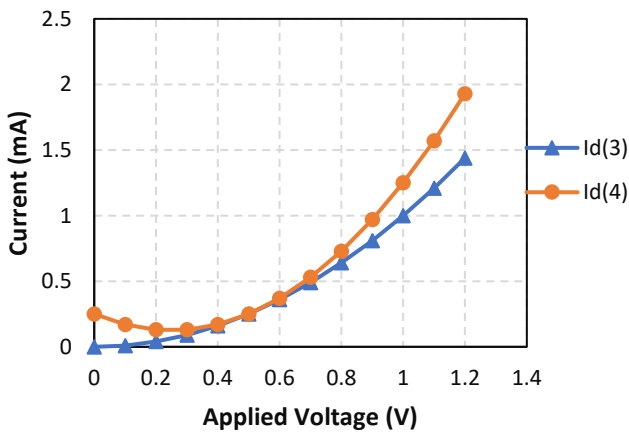

Fig. 4. Write the figure caption here. The font size of the text in the figures must be at least 8 points. Papers that violate the font size rule will be rated unfavorably..

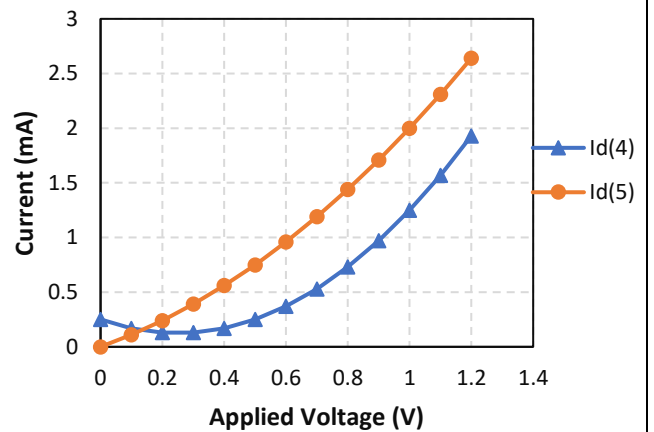

Fig. 5. Write the figure caption here. The font size of the text in the figures must be at least 8 points. Papers that violate the font size rule will be rated unfavorably..

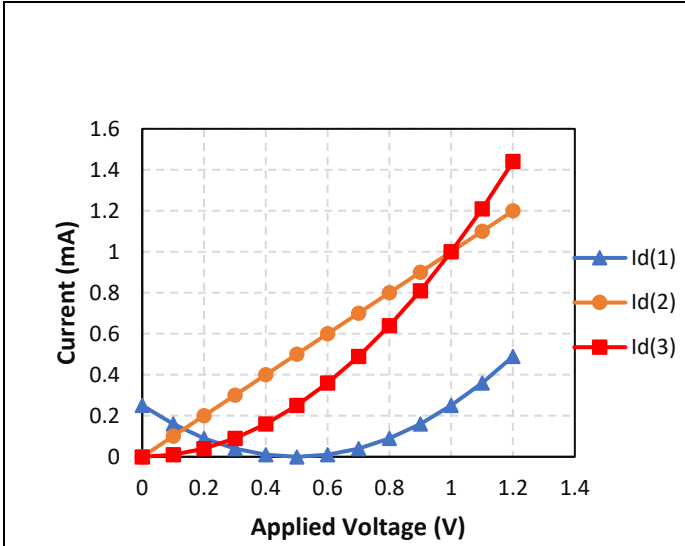

Fig. 6. Write the figure caption here. The font size of the text in the figures must be at least 8 points. Papers that violate the font size rule will be rated unfavorably..

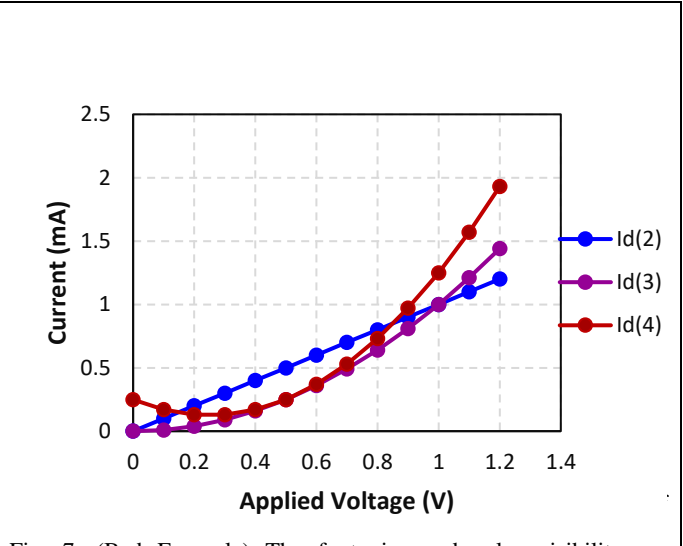

Fig. 7. (Bad Example) The font size and color visibility are acceptable, but the graph is unsuitable because a black-and-white print cannot distinguish the three trends, as they will appear in almost the same tone.

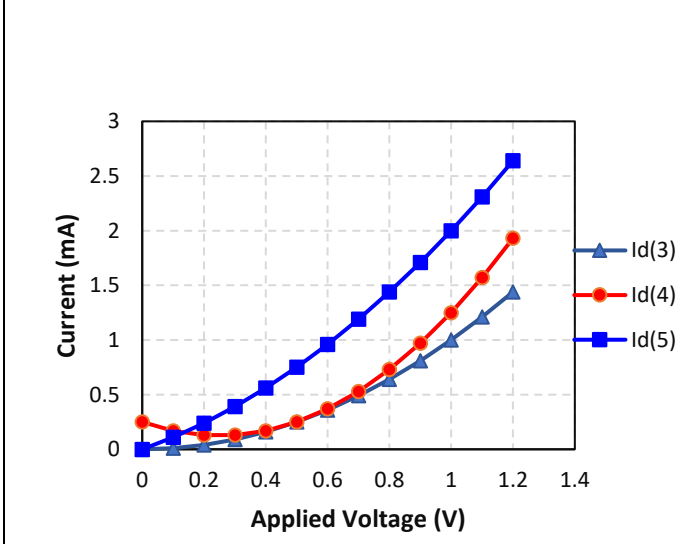

Fig. 8. Write the figure caption here. The font size of the text in the figures must be at least 8 points. Papers that violate the font size rule will be rated unfavorably..

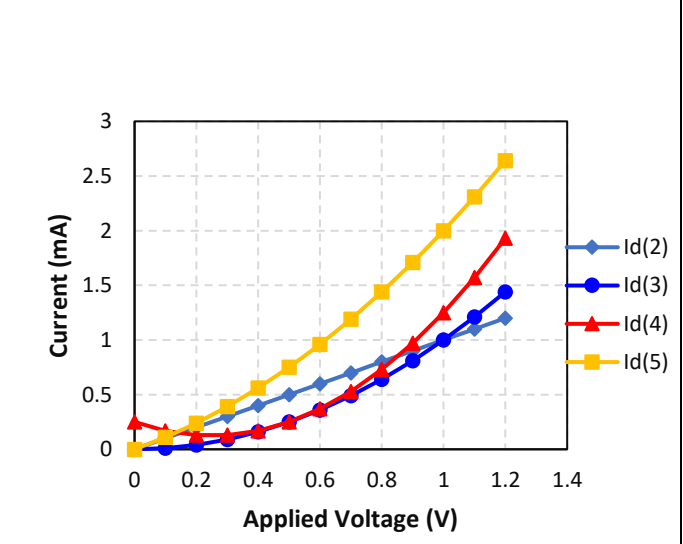

Fig. 9. Write the figure caption here. The font size of the text in the figures must be at least 8 points. Papers that violate the font size rule will be rated unfavorably..

TABLE II. Comparison with state-of-the-art AAAA circuits

	CICC'20 [1]	ISSCC'23 [2]	JSSC'23 [3]	VLSI'23 [4]	ISSCC'24 [5]	This work
Target power device	IGBT	IGBT	SiC MOSFET	Si MOSFET	GaN FET	IGBT
Sensor input	$dI_c / dt, V_{CE}$	$dI_c / dt, V_{CE}$	$dI_c / dt$	$V_{DS}$	$V_{DD}$ of high-side gate driver	$dI_c / dt$
Feedback control target	$V_{GE}$ waveform	Timing of state change	Timing of state change	Timing of state change	Timing of state change	Timing of state change
Real-time control	Yes	Yes	Yes	No	No	Yes
Number of states per switching		4	3	3	3	3
Preset parameters for each state		$I_G$	$V_{GS}$	$R_G$	$I_G$	$I_G$
Levels of parameter		NA	2	2	3	6 bit
Implementation	PCB	PCB	PCB	IC (Not fully integrated)	IC (Fully integrated)	IC (Fully integrated)
IC Process				130 nm HV CMOS	500 nm, 600 V SOI	180 nm BCD

### References

- [1] Z. Zhou *et al.*, *IEEE TED*, vol. 71, no. 8, pp. 4445–4452, 2024.
- [2] P. Jiang *et al.*, *IEDM*, 2023, pp. 1–4.
- [3] Q. Xie *et al.*, *Symp. on VLSI*, 2023, pp. 1–2.
- [4] A. Einstein, Ph. D. dissertation, XYZ-Univ., Unpublished.
- [5] T.A. Edison, in press, *ABC\_Journal*.
- [6] T. Koder, *JSAP Rev.* 2024 240101 / *Oubutsu 2023* p713-722.
- [7] G. Park *et al.*, *ISSCC*, 2024, pp. 374–376.
- [8] N. Zeng *et al.*, *Symp. on VLSI*, 2023, pp. 1–2.
- [9] T. Lu and S. Du, *CICC*, 2024, pp. 1–2.
- [10] S. Balamurali *et al.*, *ESSCIRC*, 2023, pp. 125–128.
- [11] Y. Iizuka *et al.*, *A-SSCC*, 2023, pp. 1–3.

(Example of using panes for references )